

Needle Holder & Sutures

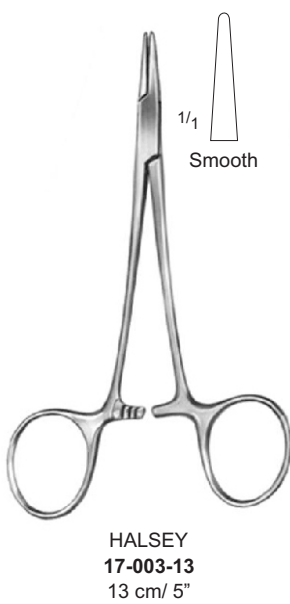

17

Needle Holders, with Tungsten Carbide T/C Inserts

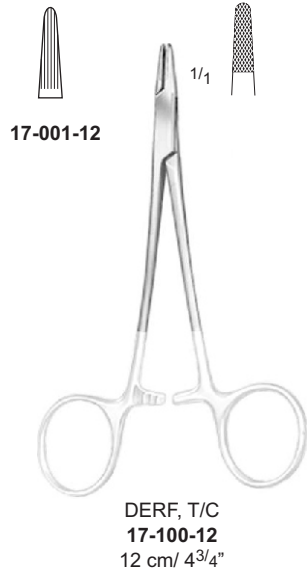

Needle Holders, with Tungsten Carbide T/C Inserts

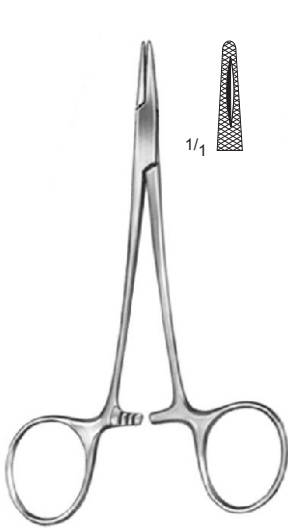

WRIGHT (DERF)
 17-012-12
 12.5 cm / 5"

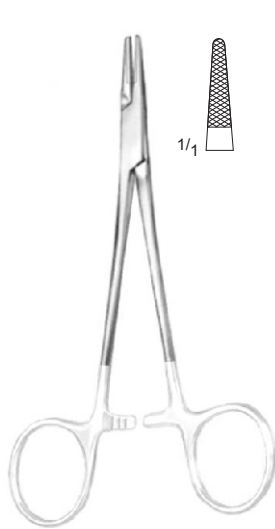

WRIGHT (DERF), T/C
 17-113-12
 12.5 cm / 5"

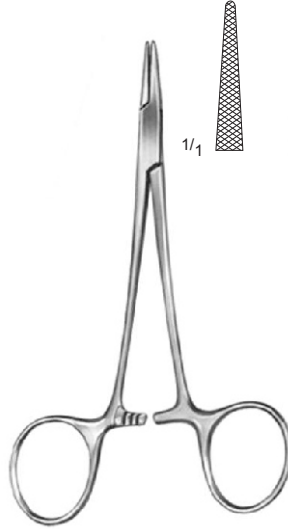

HALSEY
 17-014-13
 13.5 cm / 5 1/4"

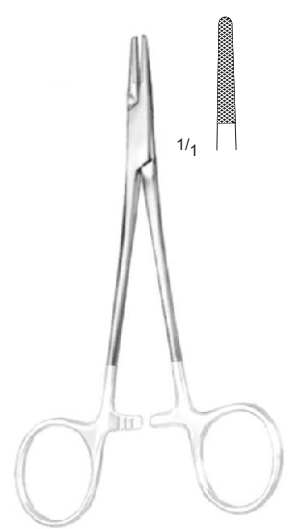

HALSEY, T/C
 17-115-13
 13.5 cm / 5 1/4"



CRILE WOOD
 17-021-18 – 17-021-23

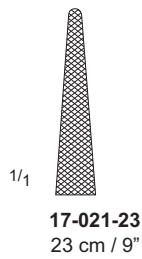
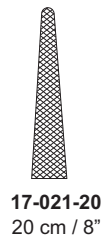
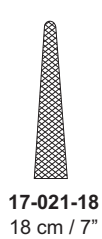

CRILE WOOD, T/C
 (DEBAKEY)
 17-122-18 – 17-122-30

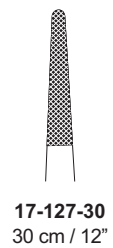
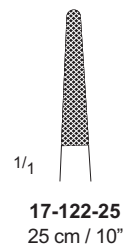
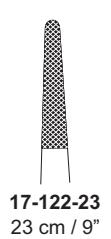
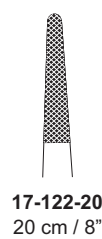
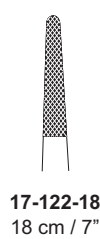

Needle Holders, with Tungsten Carbide T/C Inserts



MAYO HEGAR
 17-023-15 – 17-023-30

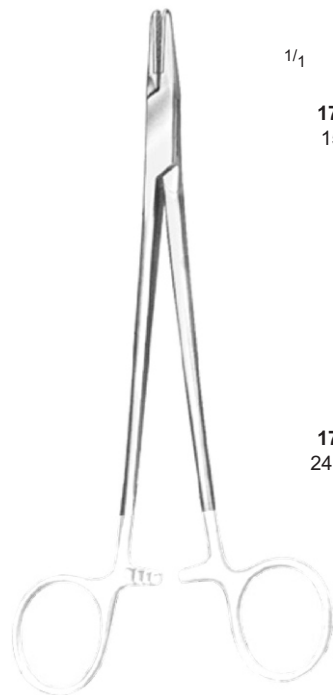
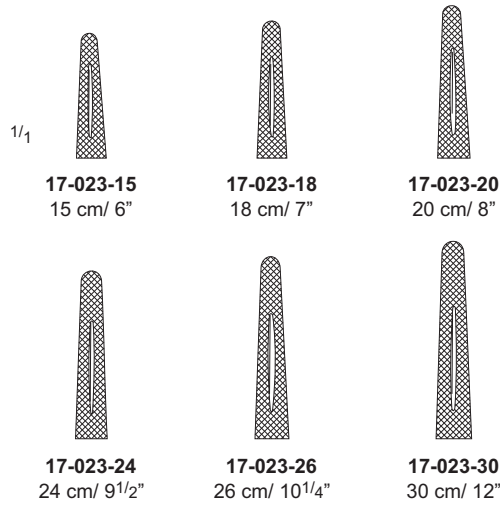

MAYO HEGAR, T/C
 17-024-15 – 17-024-30

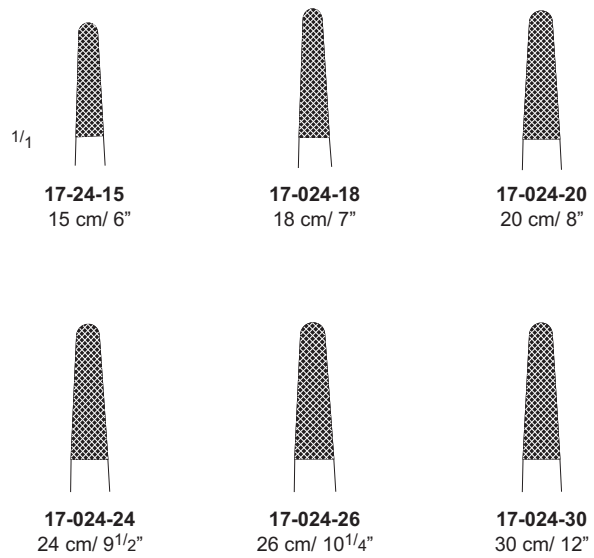

Needle Holders, with Tungsten Carbide T/C Inserts



CRILE MURRAY
 17-032-15
 15 cm / 6"



Grooved Jaws

CRILE WOOD
 17-034-15
 15 cm / 6"



CRILE WOOD, T/C
 17-035-15
 15 cm / 6"

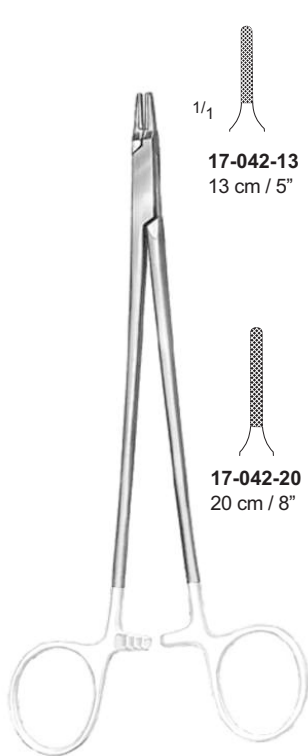

RYDER (FRENCH EYE), T/C
 17-042-13 – 17-042-25

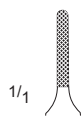

17-042-13
 13 cm / 5"



17-042-15
 15 cm / 6"



17-042-18
 18 cm / 7"



17-042-20
 20 cm / 8"



17-042-23
 23 cm / 9"



17-042-25
 25 cm / 10"

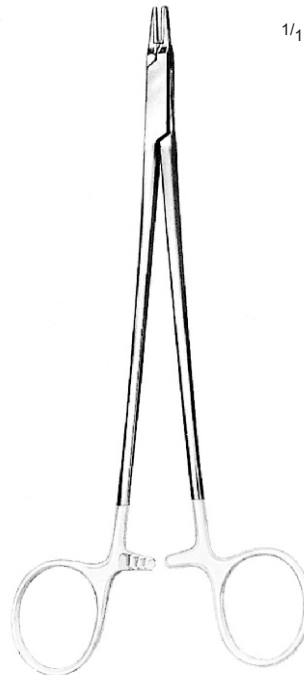

RYDER (VASCULAR), T/C
 17-044-13 – 17-044-26

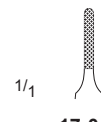

17-044-13
 13 cm / 5"



17-044-15
 15 cm / 6"



17-044-18
 18 cm / 7"



17-044-20
 20 cm / 8"



17-044-23
 23 cm / 9"



17-044-26
 26 cm / 10"

Needle Holders, with Tungsten Carbide T/C Inserts

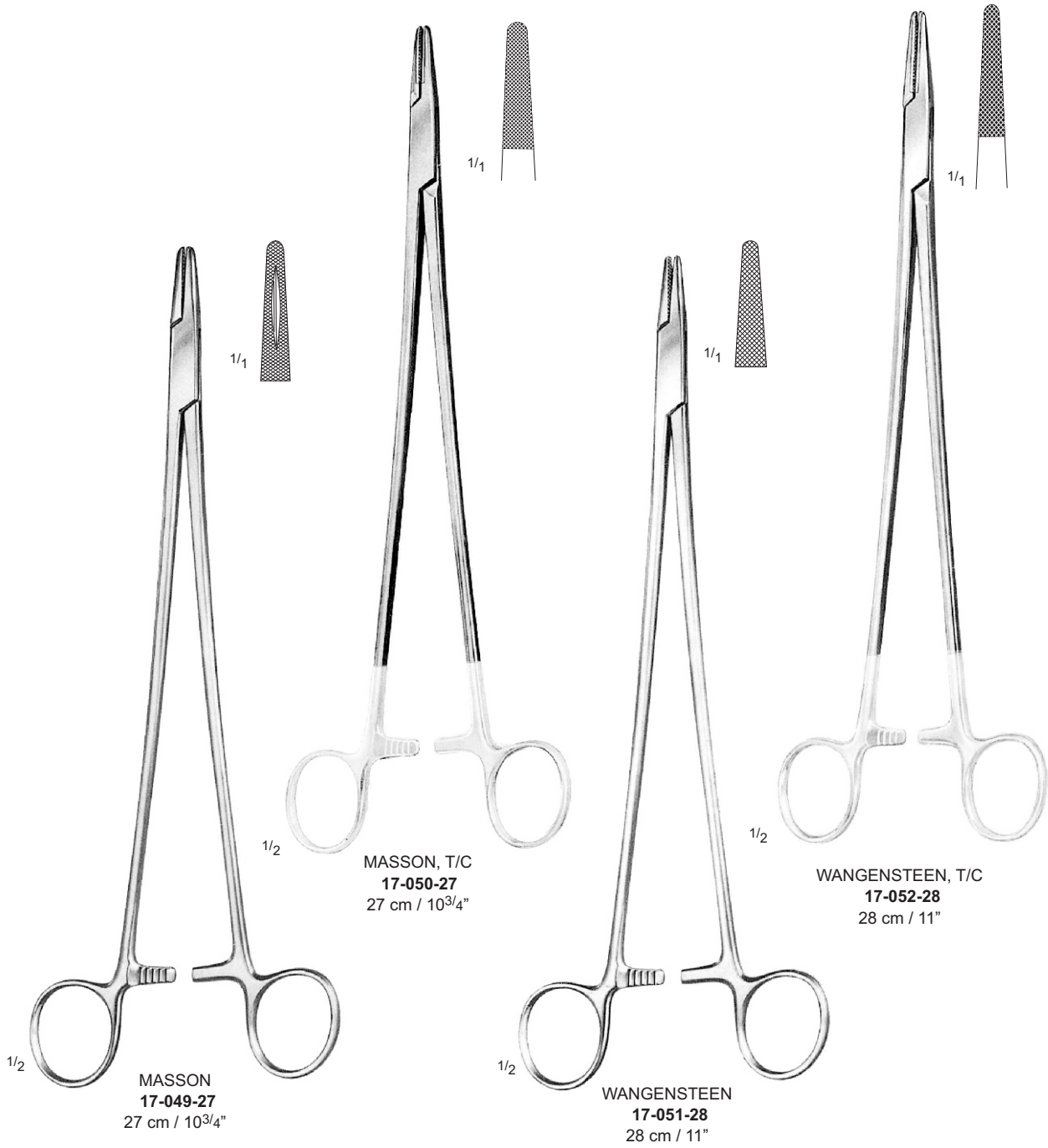

Needle Holders, with Tungsten Carbide T/C Inserts

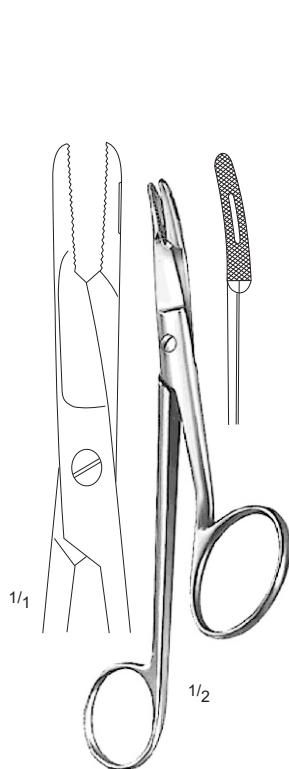

GILLIES
 17-055-15
 15 cm / 6"

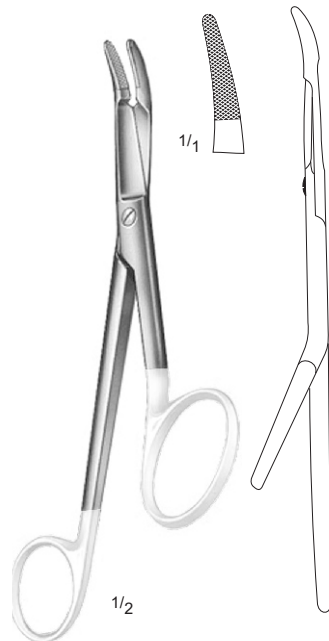

GILLIES, T/C
 17-056-16
 15 cm / 6"

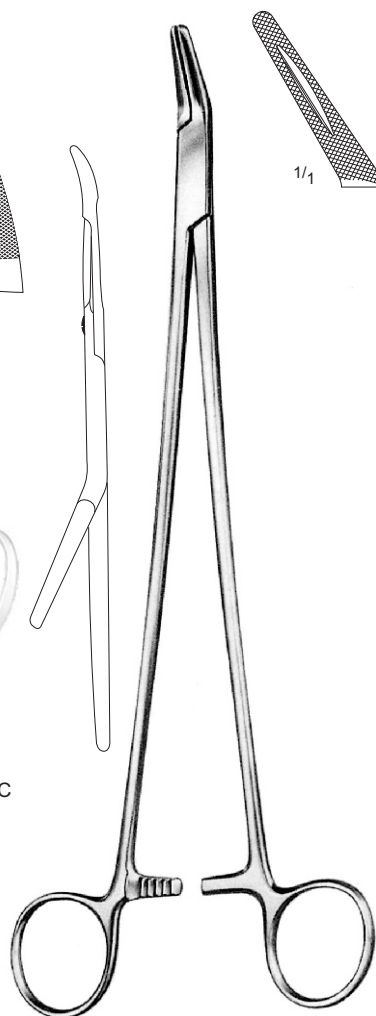

FINOCHIETTO
 17-057-27
 27 cm / 10³/₄"

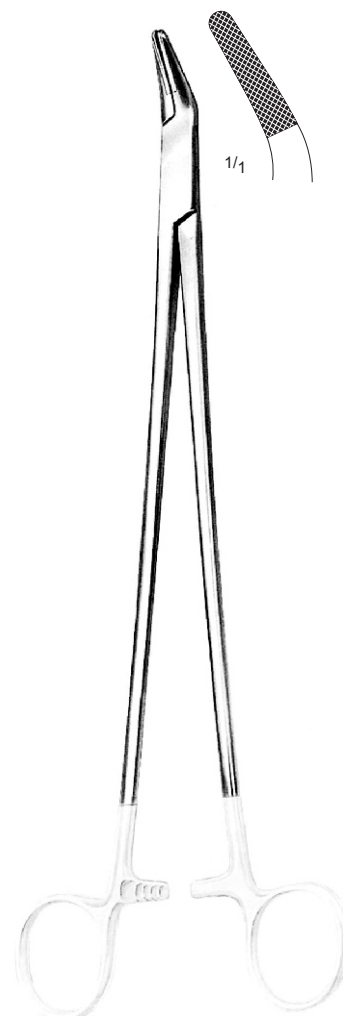

FINOCHIETTO, T/C
 17-058-27
 27 cm / 10³/₄"

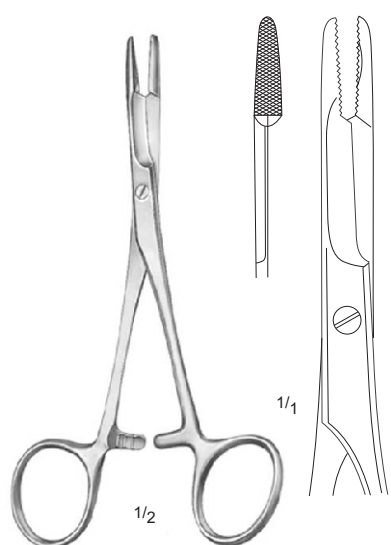

OLSEN HEGAR
 17-063-14
 14 cm / 5¹/₂"



OLSEN HEGAR, T/C
 17-064-14 – 17-064-17

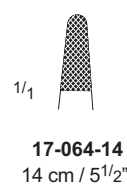

17-064-14
 14 cm / 5¹/₂"



17-064-17
 17 cm / 6³/₄"

Needle Holders, with Tungsten Carbide T/C Inserts

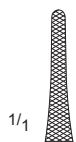

17-065-14
 14 cm / 5 1/2"



17-065-17
 17 cm / 6 3/4"

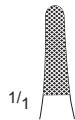

17-066-14
 14 cm / 5 1/2"



17-066-17
 17 cm / 6 3/4"



17-066-20
 20 cm / 8"



17-067-14
 14 cm / 5 1/2"

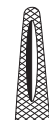

17-067-17
 17 cm / 6 3/4"

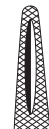

17-067-20
 20 cm / 8"

MATHIEU KOCHER
 17-065-14 - 17-065-17

MATHIEU KOCHER, T/C
 17-066-14 - 17-066-20

MATHIEU
 17-067-14 - 17-067-20

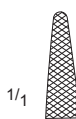

17-068-14
 14 cm / 5 1/2"



17-068-17
 17 cm / 6 3/4"



17-068-20
 20 cm / 8"



17-069-14
 14 cm / 5 1/2"



17-069-17
 17 cm / 6 3/4"



17-069-20
 20 cm / 8"



17-074-17
 17 cm / 6 3/4"



17-074-20
 20 cm / 8"

MATHIEU
 17-068-14 - 17-068-20

MATHIEU, T/C
 17-069-14 - 17-069-20

MATHIEU T/C
 17-074-17 - 17-074-20

Micro Needle Holders, with Tungsten Carbide T/C Inserts



17-203-14 17-204-15



CASTROVIEJO - STANDARD
 17-103-14 – 17-104-15
 14 cm / 5 1/2"



17-205-44 17-206-45



CASTROVIEJO - STANDARD
 17-103-44 – 17-104-45
 14 cm / 5 1/2"

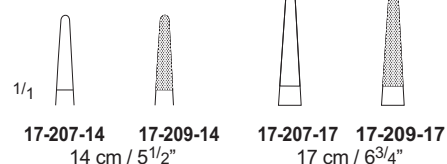

17-207-14 17-209-14
 14 cm / 5 1/2"



CASTROVIEJO
 (JACOBSON) T/C
 17-105-14 – 17-105-47

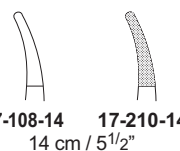

17-108-14 17-210-14
 14 cm / 5 1/2"

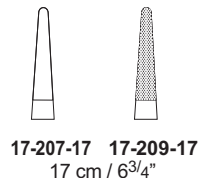

17-207-17 17-209-17
 17 cm / 6 3/4"

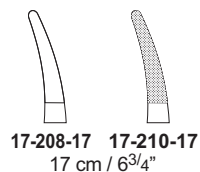

17-208-17 17-210-17
 17 cm / 6 3/4"



17-211-14 17-212-14



CASTROVIEJO - MICRO
 17-211-14 – 17-212-14
 14 cm / 5 1/2"

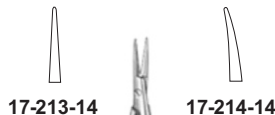

17-213-14 17-214-14



CASTROVIEJO - MICRO
 17-213-14 – 17-214-14
 14 cm / 5 1/2"

Ligature Needles

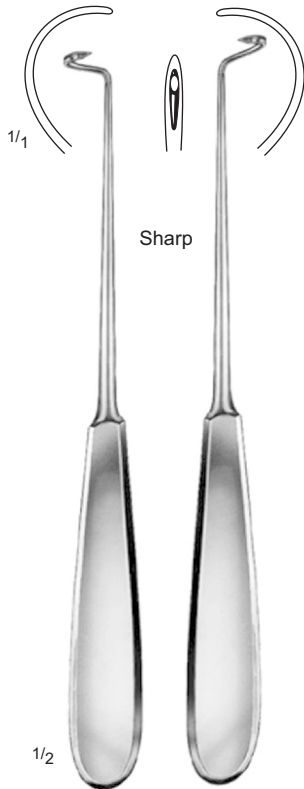

DESCHAMPS - BABY
17-151-20 17-152-20
20 cm / 8"

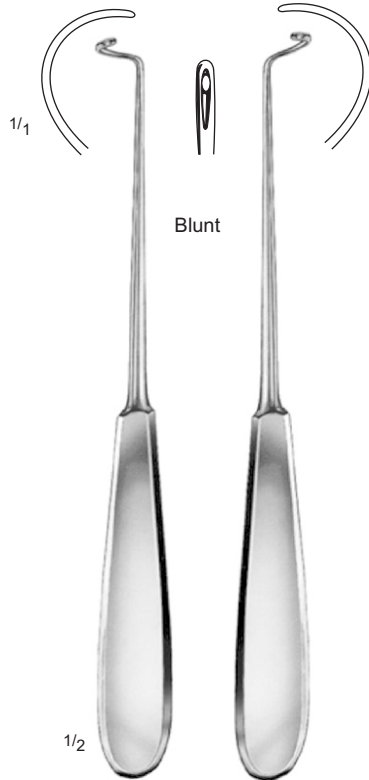

DESCHAMPS - BABY
17-153-20 17-154-20
20 cm / 8"

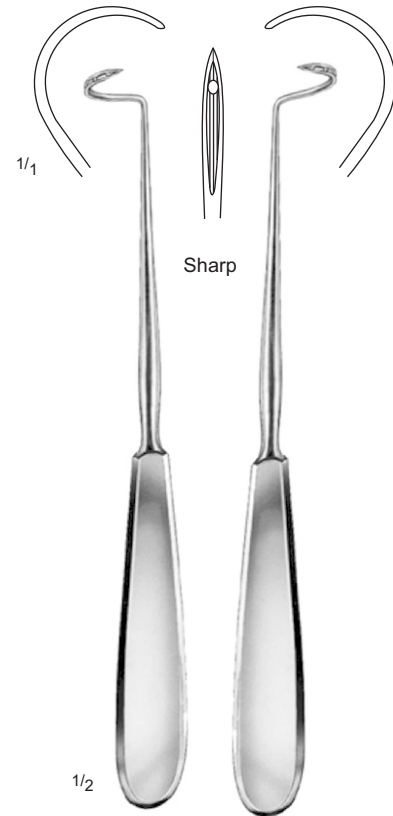

DESCHAMPS - BABY
17-155-20 17-156-20
20 cm / 8"

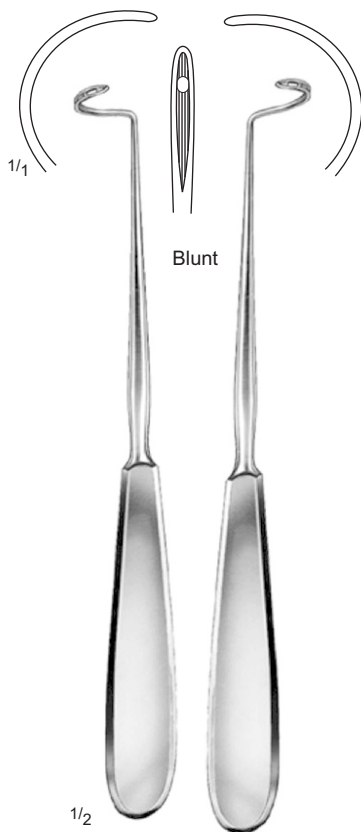

DESCHAMPS
17-157-20 17-158-20
20 cm / 8"

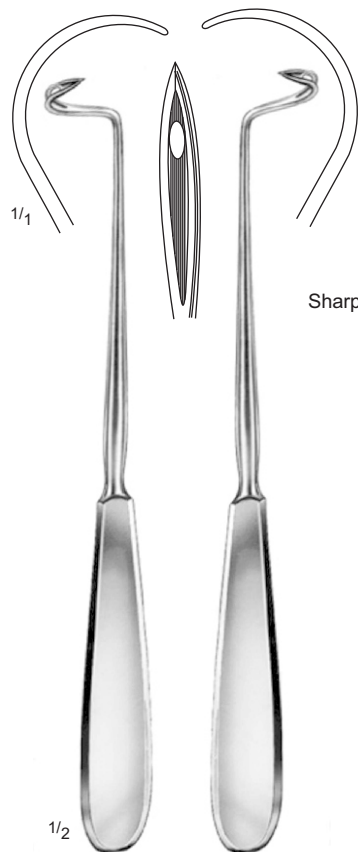

DESCHAMPS
17-159-20 17-160-20
20 cm / 8"

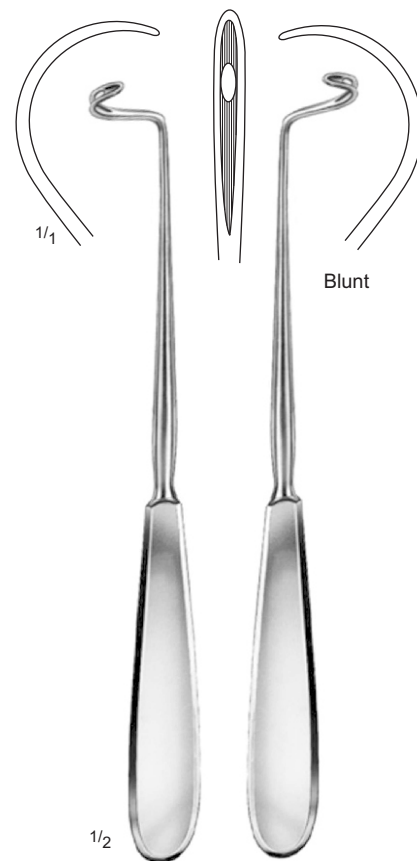

DESCHAMPS
17-161-20 17-162-20
20 cm / 8"

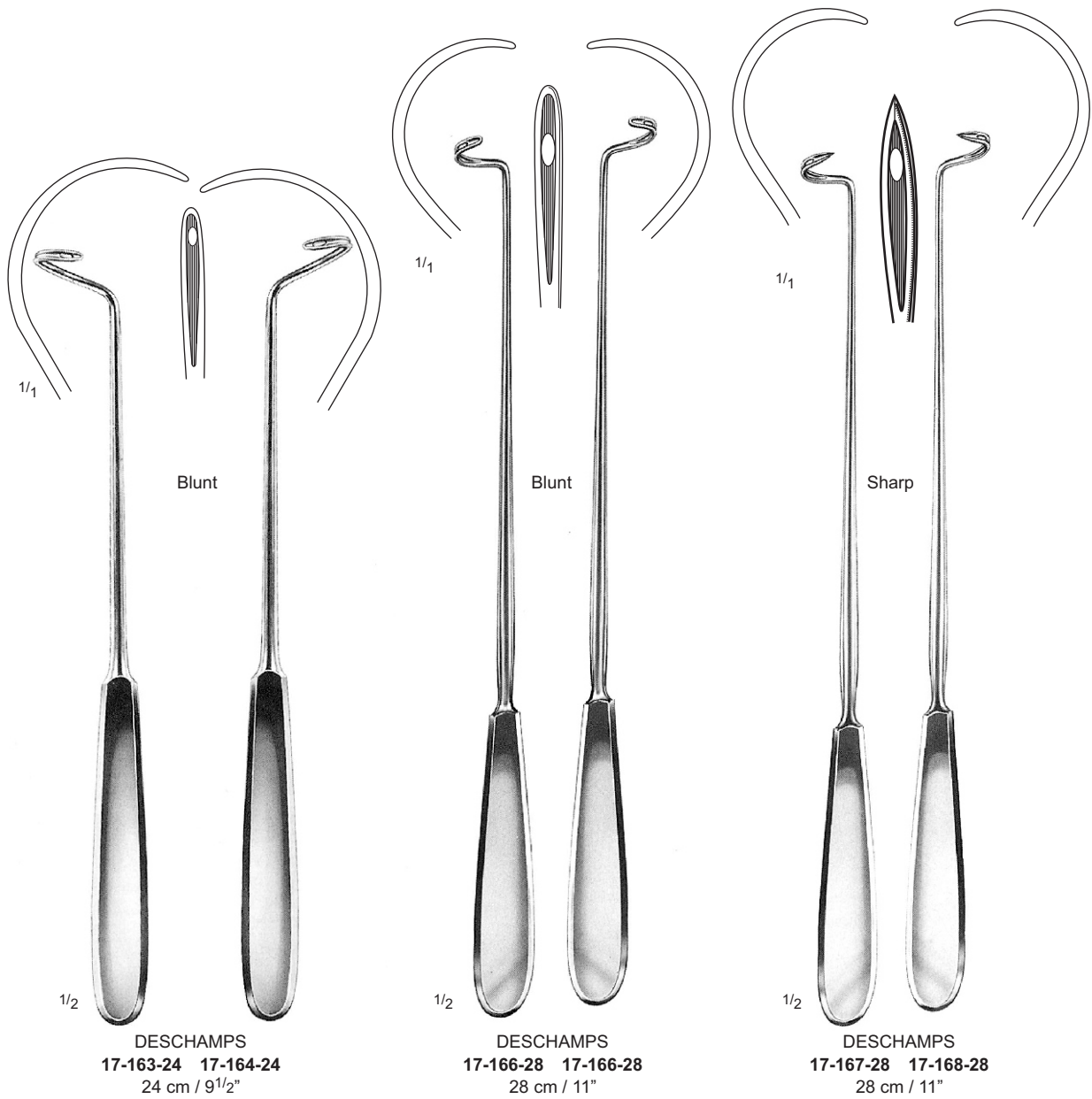

Reverdin Needles

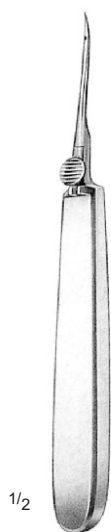

1/2

REVERDIN
17-171-14 – 17-107-14
14 cm/ 5 1/2"

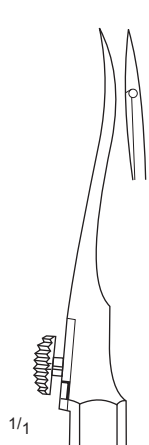

1/1

17-171-14
1

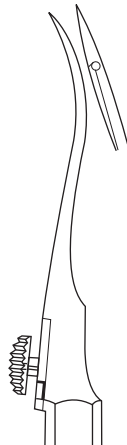

17-172-14
2

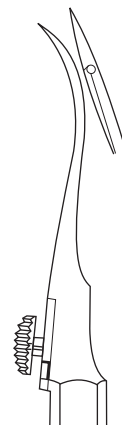

17-173-14
3

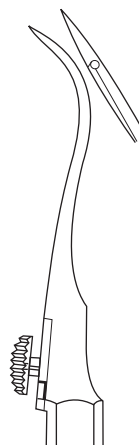

17-174-14
4



1/2

REVERDIN
17-176-19 – 17-179-19
19 cm/ 7 1/2"

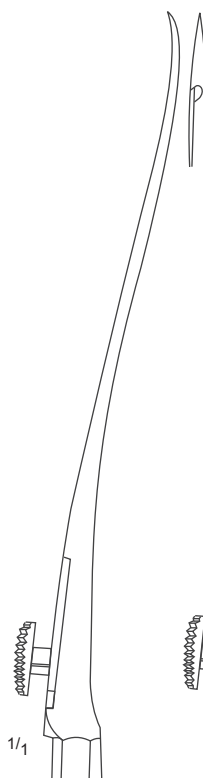

1/1

17-176-19
17-176-22

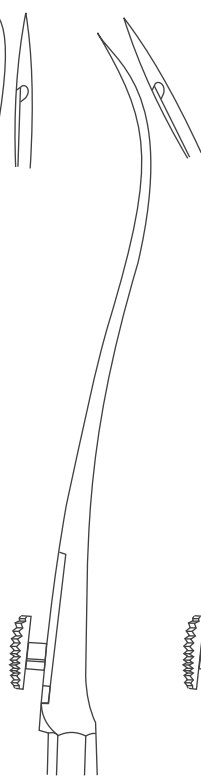

17-177-19
17-177-40

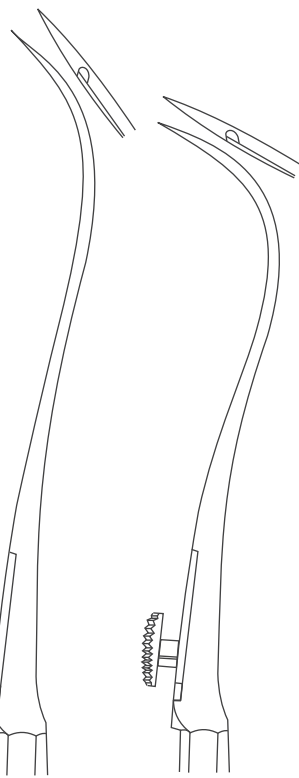

17-178-19
17-178-22

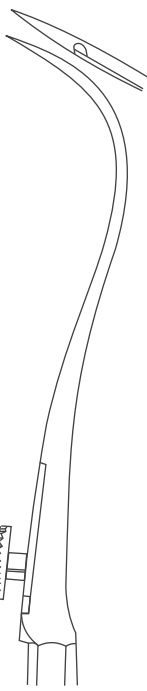

17-179-19
17-179-22



1/2

REVERDIN
17-176-22 – 17-179-22
22.5 cm/ 8 3/4"

Clip Applying and Removing Forceps, Ligature Scissors



1/2
MICHEL
17-109-12
12.5 cm / 5"



1/2
HEGENBARTH
17-110-12
12 cm / 4 3/4"



1/2
MICHEL
17-111-12
12 cm / 4 3/4"



1/2
COLLIN
17-117-13
13 cm / 5"

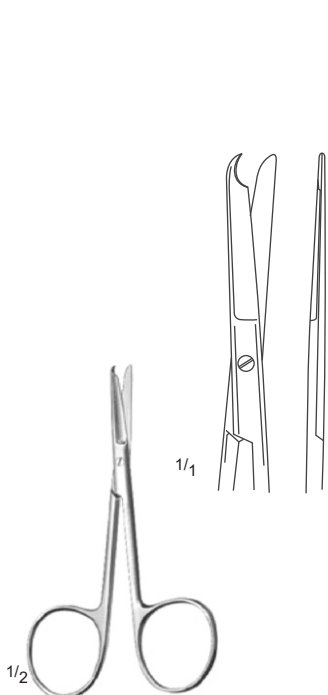

1/2
SPENCER
17-119-09
9 cm / 3 1/2"

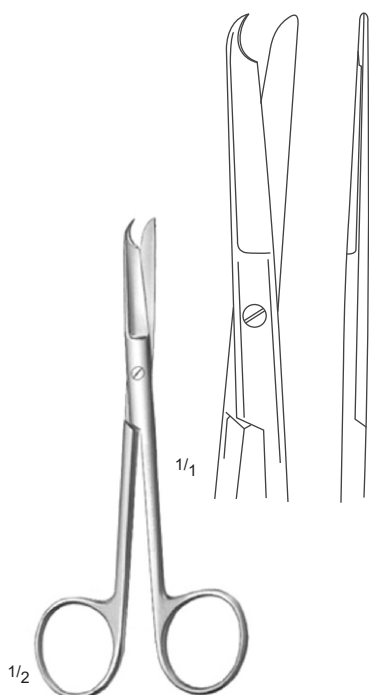

1/2
SPENCER
17-120-10 – 10.5 cm / 4"
17-120-12 – 12 cm / 4 3/4"
17-120-14 – 14 cm / 5 3/4"

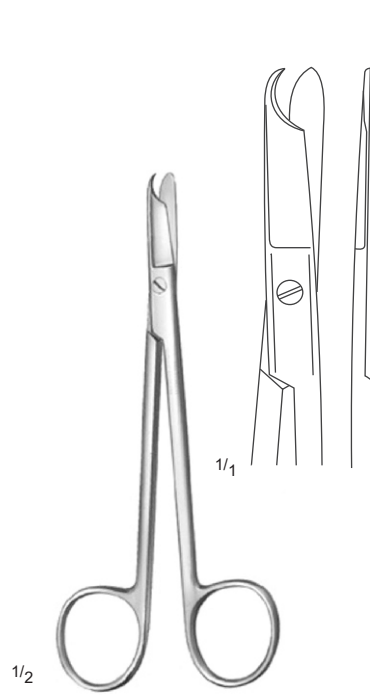

1/2
LITTAUER
17-121-13
13 cm / 5"

Wire Cutting Scissors

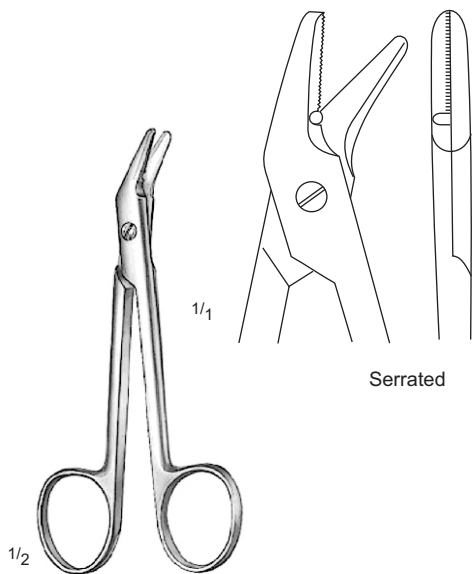

UNIVERSAL
17-123-12
12 cm / 4³/₄"

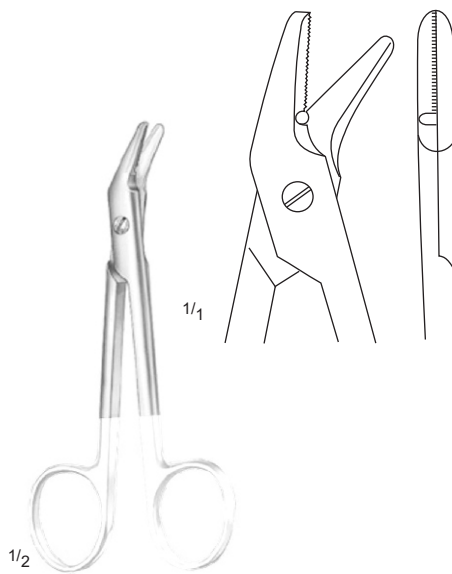

UNIVERSAL, T/C
17-124-12
12 cm / 4³/₄"

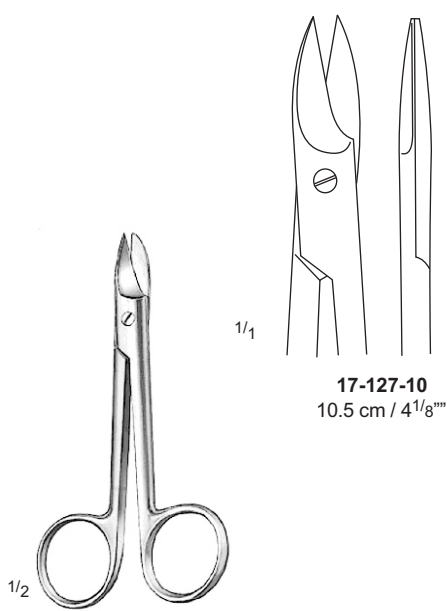

BEE BEE
17-127-10 – 17-129-10

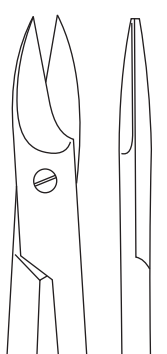

17-127-10
10.5 cm / 4¹/₈"

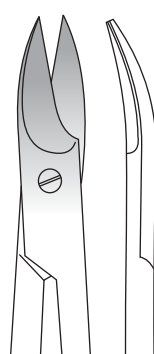

17-128-10
10.5 cm / 4¹/₈"

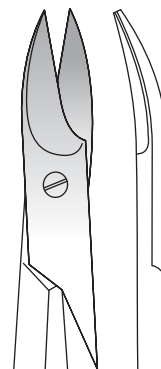

17-129-10
10.5 cm / 4¹/₈"
one blade serrated