

# UROLOGY

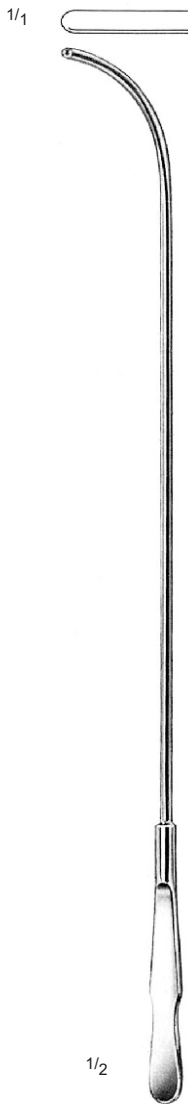

Urethral Sounds, Metal Catheters



**VAN BUREN**  
**30-006-08 – 30-006-30**  
 27.5 cm / 11"  
 Charrier (French)  
 No. (8–30)

**CHARRIERE**  
(French)

VAN BUREN	GUYON	
<b>30-006-08</b>	8	–
<b>30-006-10</b>	10	<b>30-007-10</b>
	11	<b>30-007-11</b>
<b>30-006-12</b>	12	<b>30-007-12</b>
	13	<b>30-007-13</b>
<b>30-006-14</b>	14	<b>30-007-14</b>
	15	<b>30-007-15</b>
<b>30-006-16</b>	16	<b>30-007-16</b>
	17	<b>30-007-17</b>
<b>30-006-18</b>	18	<b>30-007-18</b>
	19	<b>30-007-19</b>
<b>30-006-20</b>	20	<b>30-007-20</b>
	21	<b>30-007-21</b>
<b>30-006-22</b>	22	<b>30-007-22</b>
	23	<b>30-007-23</b>
<b>30-006-24</b>	24	<b>30-007-24</b>
	25	<b>30-007-25</b>
<b>30-006-26</b>	26	<b>30-007-26</b>
	27	<b>30-007-27</b>
<b>30-006-28</b>	28	<b>30-007-28</b>
	29	<b>30-007-29</b>
<b>30-006-30</b>	30	<b>30-007-30</b>
<b>30-006-00</b>	<b>30-007-00</b>	
(Set of 12, pcs)	(Set 21, pcs)	

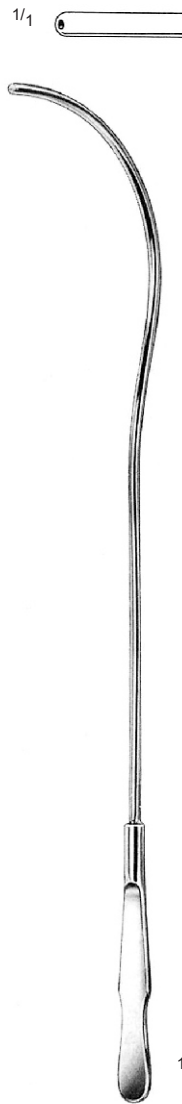

**GUYON**  
**30-007-10 – 30-007-30**  
 27.5 cm / 11"  
 Charrier (French)  
 No. (10-30)

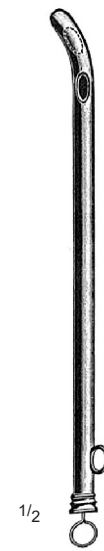

**Charriere**  
(French)

<b>30-007-06</b>	– 6
<b>30-007-08</b>	– 8
<b>30-007-10</b>	– 10
<b>30-007-12</b>	– 12
<b>30-007-13</b>	– 13
<b>30-007-14</b>	– 14
<b>30-007-15</b>	– 15
<b>30-007-16</b>	– 16

**30-008-06 – 30-008-16**  
 Charrier (French)  
 No. 6–16,  
 16 cm / 6 1/4"

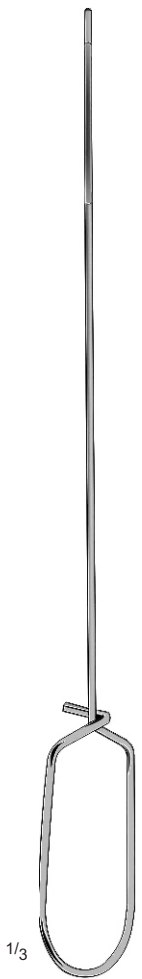

GUYON  
30-009-36  
36 cm / 14 1/4"

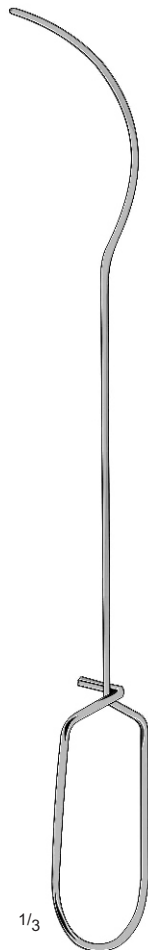

GUYON  
30-010-36  
36 cm / 14 1/4"

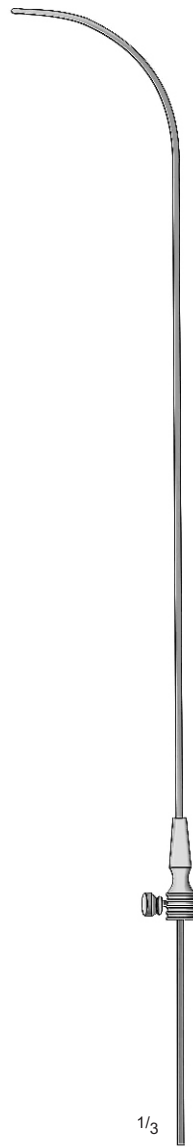

DITTEL  
30-011-39  
39 cm / 15 1/2"

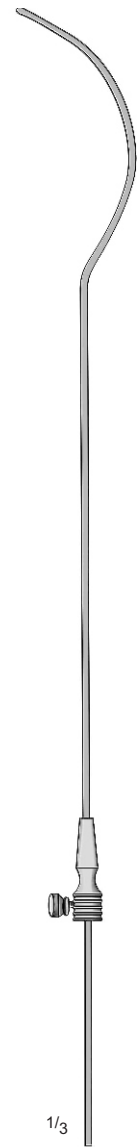

30-012-39  
39 cm / 15 1/2"

Bladder Spatula & Retractors



LEGUEU  
30-016-35  
27 cm / 10 1/2"

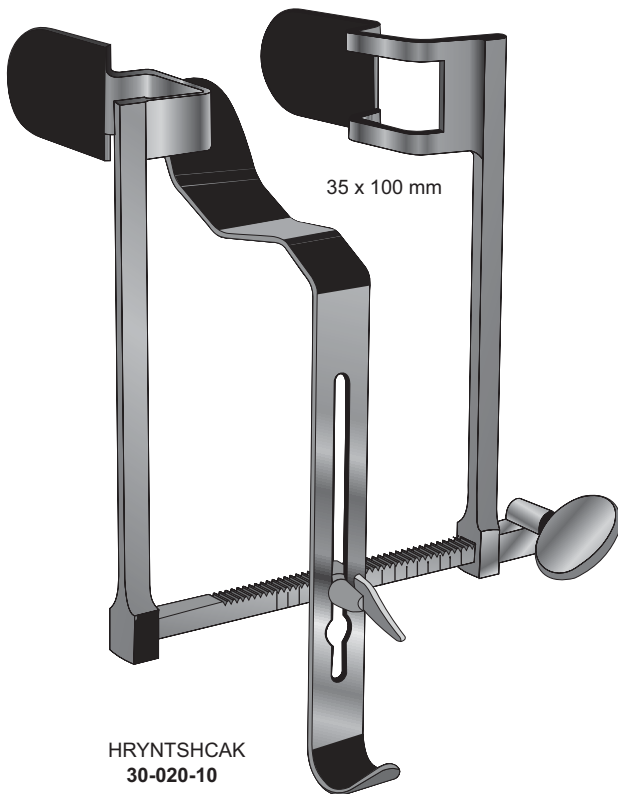
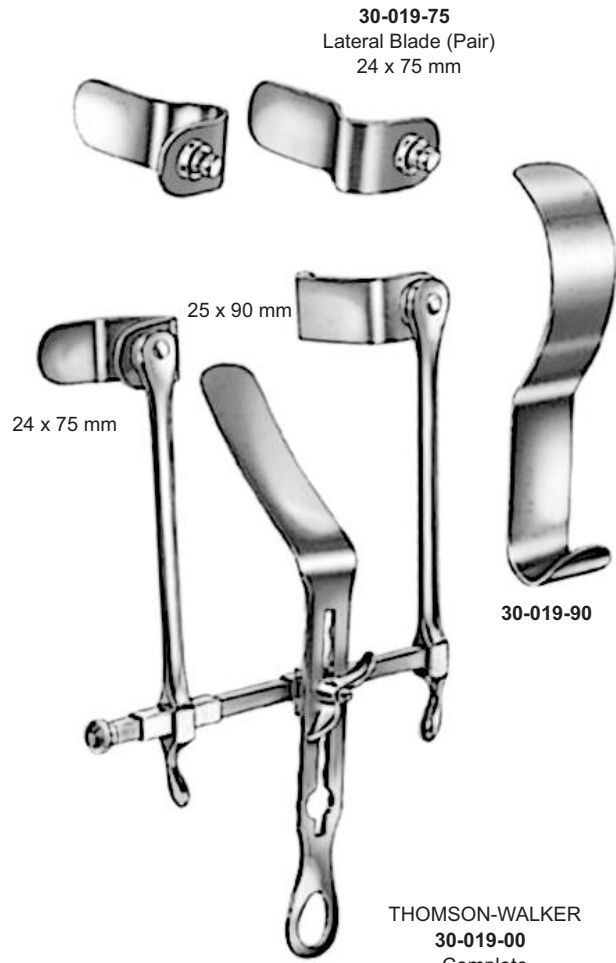

Prostatic Retractors, Prostatic Instruments

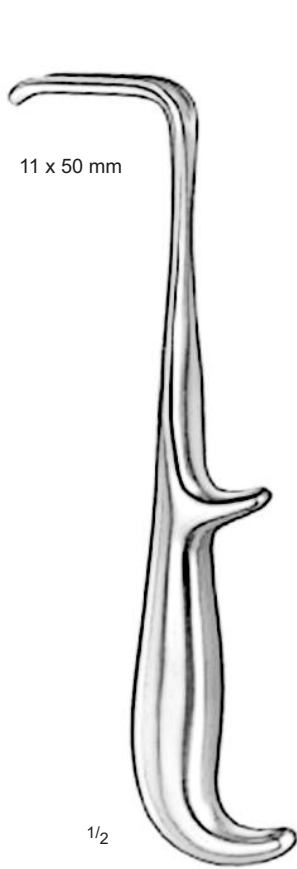

YOUNG  
 30-023-21  
 21 cm / 8 1/4"



YOUNG  
 30-024-22  
 22 cm / 8 3/4"



YOUNG  
 30-025-13  
 21 cm / 8 1/4"

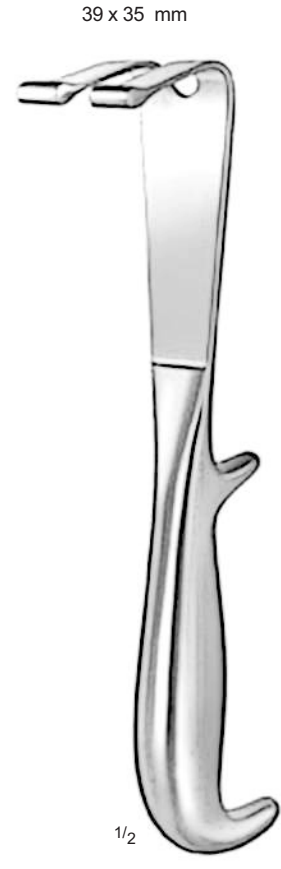

YOUNG  
 30-028-22  
 22 cm / 8 3/4"

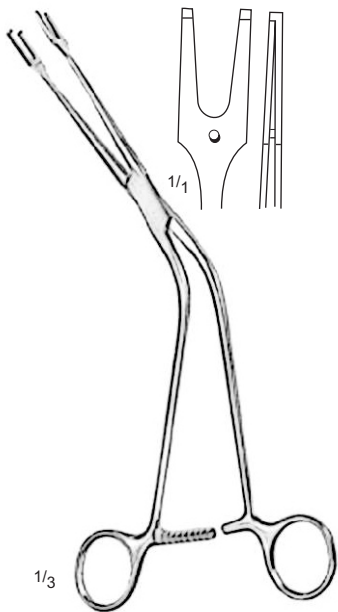

MILLIN  
 30-026-24  
 24 cm / 9 1/2"

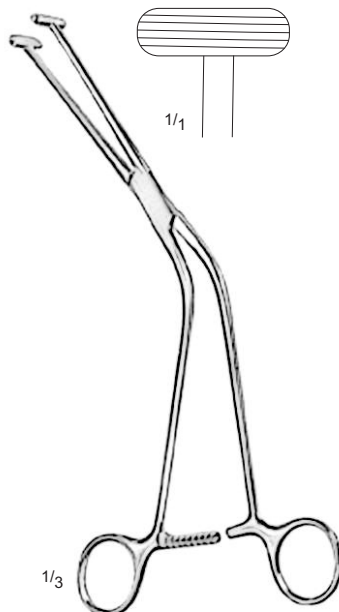

MILLIN  
 30-031-23  
 23 cm / 9"

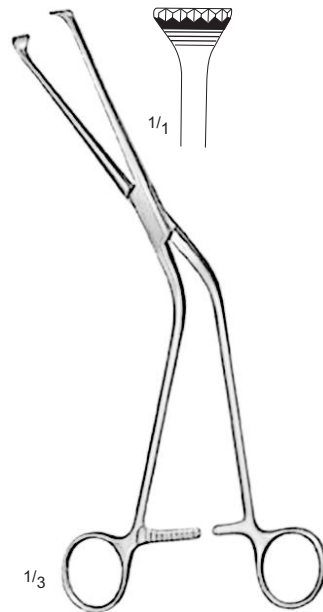

MILLIN  
 30-032-23  
 23 cm / 9"

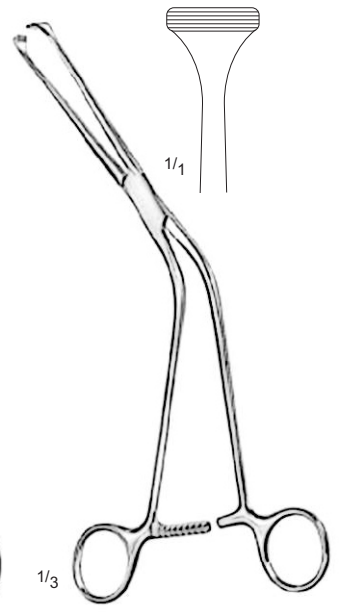

MILLIN  
 30-032-23  
 23 cm / 9"

Bladder Neck Spreader, Meatus Clamps, Foreign Body Forceps



**MILLIN**  
**30-033-28**  
28 cm / 11"

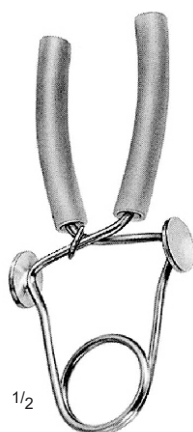

**STRAUSS**  
**30-004-12**  
12 cm / 4 3/4"



**STOCKMANN**  
**30-005-08**  
8 cm / 3 1/8"

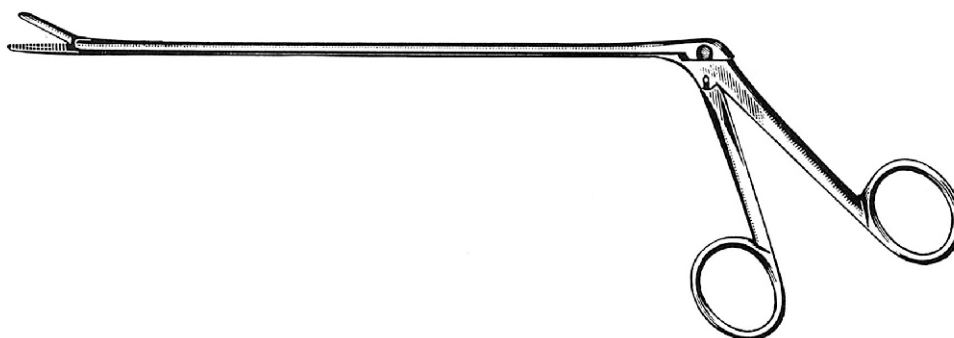

**MATHIEU**  
**30-021-20** – 20 cm / 8"  
**30-021-28** – 28 cm / 11"

Kidney Stone Forceps

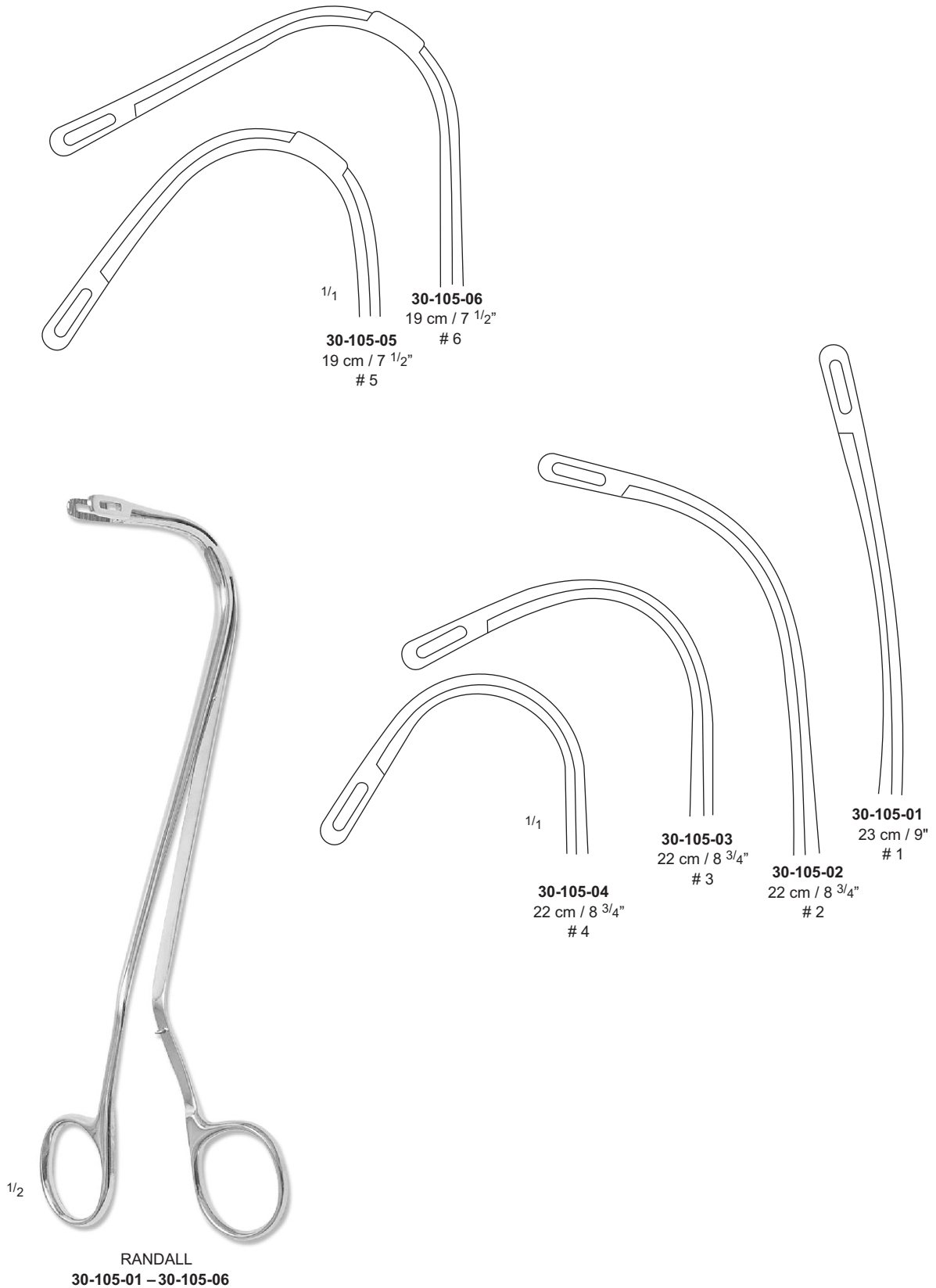

Kidney Pedicle Clamps, Vaginal Forceps

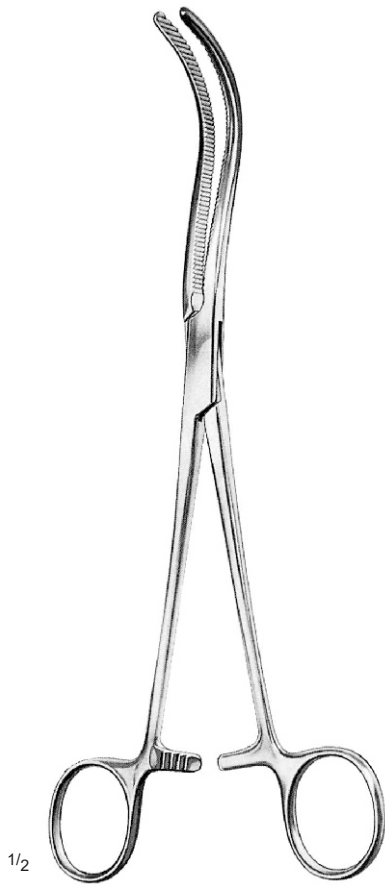

GUYON  
 30-115-20 - 30-115-24

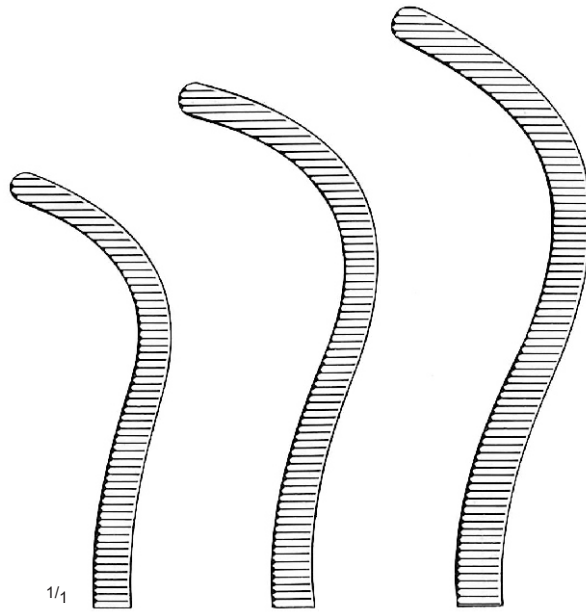

30-115-20  
 20 cm / 8"

30-115-22  
 22 cm / 8 3/4"

30-115-24  
 24 cm / 9 1/2"

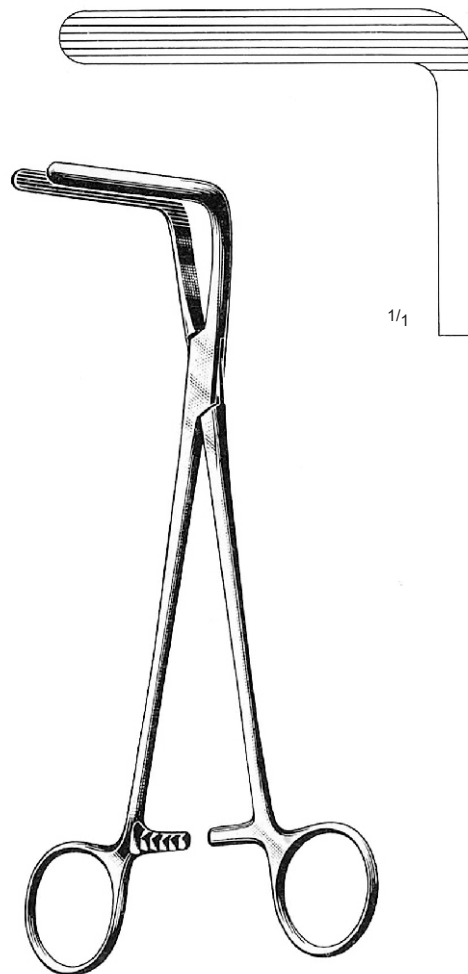

WERTHEIM-CULLEN  
 30-104-23  
 23 cm / 9"



Kidney Pedicle Clamps

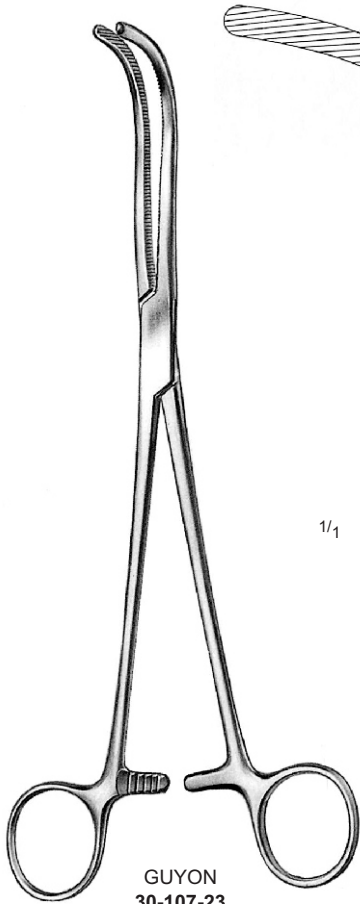

GUYON  
 30-107-23  
 23 cm / 9"



GUYON-MAYO  
 30-108-23  
 23 cm / 9"

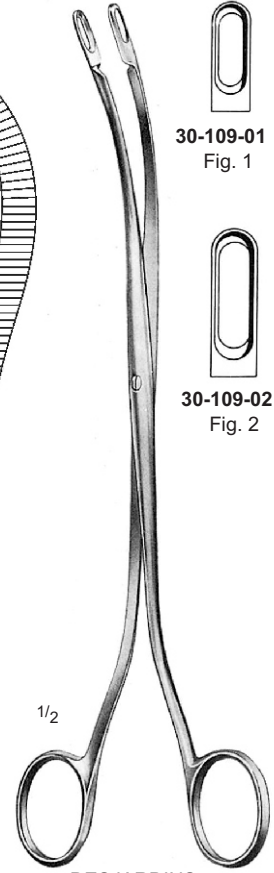

DESJARDINS  
 30-109-01 – 30-109-02  
 23 cm / 9"

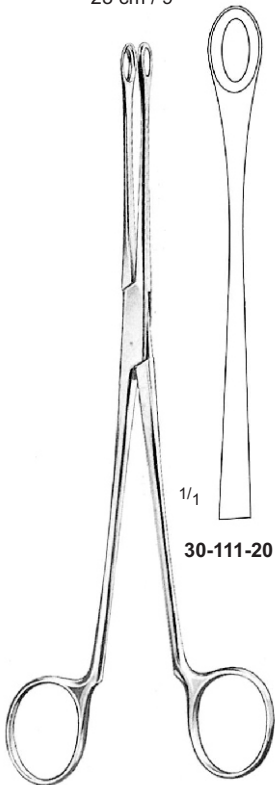

BLAKE  
 30-111-20 – 30-112-20  
 20 cm / 8"

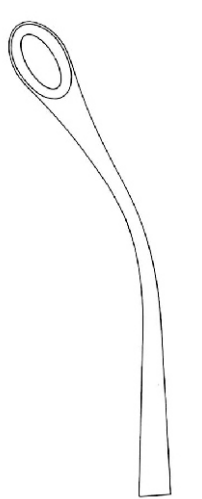

30-112-20

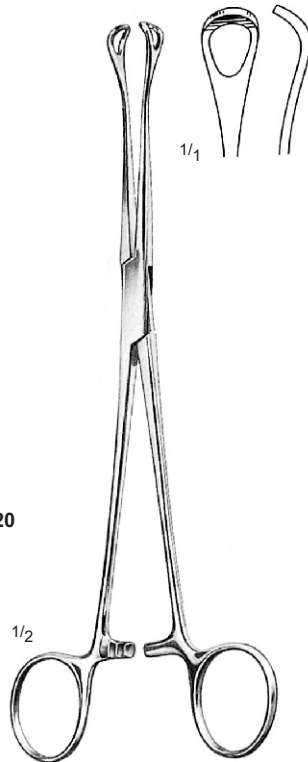

MAYO-BLAKE  
 30-113-20  
 20 cm / 8"



MAYO-BLAKE  
 30-114-20  
 20 cm / 8"

Gall Bladder Scissors, Probes, Dilators



**THOREK**  
 30-116-19 – 19 cm / 7 1/2"  
 30-116-23 – 23 cm / 9"



**BAKES**  
 30-132-01 – 30-132-13  
 32 cm / 13"  
 Malleable Shaft  
 30-132-00  
 Set of 13 dilators

